

ENG

Automatic Industrial Overhead Doors



Advanced entrance technology

DITEC automatic overhead doors

The ideal solution for all industrial needs

Best use of transit openings. Weather resistant. Maximum safety.

DITEC overhead doors offer a range of real and amazing advantages.

Their compact size leaves more available space both inside and outside the premises

DITEC sectional overhead door side runners move vertically along the wall and parallel to the ceiling, ensuring optimal use of the available internal space. Furthermore, their installation above the opening fully exploits the transit opening.

Easy and practical to open and operate

Their compact size ensures more available space both inside and outside the premises. They are also practical and easy to use, especially with original DITEC motors.

More environmental control

Their heat insulation and soundproofing, ensured by insulated panels, improves internal living conditions and energy consumption.

Light and aesthetically pleasing environments

The panels can also be manufactured with the addition of practical portholes or full aluminium sections featuring polycarbonate or unbreakable glass panels, wire meshing or air grilles.

They add value to the premises and meet all requirements

The design and different solutions offered ensure the door to be aesthetically pleasing and perfectly suited in any architectural environment - from modern and traditional industrial buildings to fine commercial buildings. The doors can meet any industrial and commercial requirement and add value to the building they are installed on. DITEC doors are built to ensure the highest ease and flexibility of use which, in turn, ensures a quick, hassle free and accurate replacement of old doors.

Reliability

DITEC has been awarded ISO 9001-VISION 2000 and IQ NET certifications. All products are affixed with a CE mark.

Technical features of the product range.

For transit openings up to 8 m wide

Minimum space required on the lintel - 200 mm

Distinctive features of models offered

DITEC overhead door panels are sturdy and ensure a high heat insulation and soundproofing.

The galvanised material used and the sandwich-type frame effectively protect it from the elements.

The core insulated with high-density (48 kg/m³), CFC-free polyurethane foam offers high protection from outside temperatures.

DITEC overhead door panels are 40 mm thick and are available in two heights - 500 mm and 610 mm.

The doors are available with streaked effect horizontal louvre motif, cassette and Flat (upon payment of a surcharge).

One of the smallest heat insulation coefficient!

Thermal transmittance according to standards
UNI EN 13241 appendix B, UNI EN 12428,
UNI EN ISO 10077-2, UNI EN ISO 10211-2
 $U_w = 1.18 \text{ W/m}^2\text{K}$



Wide range of colours and finishes offered

Standard
streaked grooved



White

similar to RAL 9010W



Silver

similar to RAL 9006W



Green

similar to RAL 6005W



Dark Brown

similar to RAL 8014W



Inside

similar to RAL 9010E

Optionals



Streaked cassette



Streaked cassette

in the colours of Teak and Nogal wood

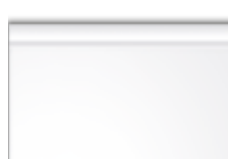

Full Flat

in the colour of White RAL 9010



Grooved Flat

in the colours of Teak and Nogal wood

Colours printed on paper may not match the original colour; it is therefore advisable to refer to official RAL tables, also when selecting customised colours. Panels can also be used.



Lisbon
Doors for industrial vehicle transit.



Lisbon
Loading bays for logistic operations.



Gold Alu
Window sectioned doors with anodised or painted aluminium sections for commercial applications.

Lisbon

Safety. Large openings.

This is the universal door for your working environment. The door is ideal for opening and closing transit openings to take goods to your own vehicles or to your suppliers' vehicles. This door is suitable for any installation requirement and leaves all the space required inside the building. Lisbon is offered in the configuration for medium and large openings with galvanised insulated steel panels.

To select the correct installation solution and to check all standard and optional parts, see the technical data sheets and ask information on safety standards, which are a major issue in all DITEC projects.



Optimises goods transit.

Lisbon is also the perfect solution to close a goods loading bay.

It is equipped with a mechanically-operated sliding device specially designed to be installed in series, as required in logistics centres.

The shape of the vertical guides and the location of the torsion springs ensure an easy and rational installation and make the Lisbon model a very cost-effective solution.



Gold Alu

Light and pleasant environments. Maximum internal/external visibility. Modern and attractive frame.

Gold Alu is a DITEC sectional overhead door designed to be combined with thermally insulated panels and extruded aluminium panels, shaped for inserting methacrylate, glass, gridded or meshed windows.

This combination gives the door a very distinctive look, which enhances the face of both commercial and industrial buildings, where Gold Alu blends in perfectly as a practical and decorative feature.

Gold Alu makes the environment light and pleasant to work in as it allows natural light to go through the large clear area.

The aluminium profiles and the methacrylate or 3+3 chamber glass window sections are highly resistant to the elements and ensure a longer life of the door.



Acrylic panel with 3+9+3 mm chamber

See-through acrylic or satin-finish 3 mm panel
See-through or satin-finish 3+3 mm unbreakable glass

Aluminium air grille

Painted drawn wire meshing



Safety devices give peace of mind during operation

All DITEC doors are fitted with standard or optional safety devices

Torsion springs

The steel torsion springs (manufactured to DIN 17223 standards) have been designed to ensure a standard life from 10,000 to 100,000 operation cycles. With standard compliant spring safety.

Safety device against spring breakage

This special device immediately stops the door panel from closing in the event of balancing spring breakage.

Anti-pinching guard

Avoids the risk of fingers from being pinched if a hand is rested on the door moving panel.

Safety device against cable breakage

This special device immediately stops the door panel from moving in case of breakage of the return cables.

Infra-red photocells

The panel down movement is automatically stopped or reversed if the infrared beam is broken.

Moving photocells

Electronic DSS safety device complete with moving photocells, without contact on obstacle (as standard for automatic version).



Accessories meet all business requirements



Handles

Sturdy and ergonomic, they have been designed to ensure ease of manual door operation.



Window sections

Natural or lacquered aluminium window, with single or double methacrylate panels and glazing bars.



PVC air grilles

These avoid condensation and vent any fumes to the outside.



Perimeter Seals

The seals are made of special anti-ageing rubber and are located on the ends of the doors and on the side of the transit opening. They ensure total insulation thus avoiding the ingress of air, dust and water.



Portholes

Oval or rectangular in acrylic material, with polycarbonate panels with chamber, glazing bars and stretched ventilation net.



Pedestrian door

When the door is frequently used for pedestrian access, a side entrance can be fitted to the door or a pedestrian passage can be added in the door panel, without interfering with its look.

Sliding system vertical section drawings: types of installation

DITEC offers several technical solutions, suited to any type of frame.
Minimum lintel size - 200 mm.

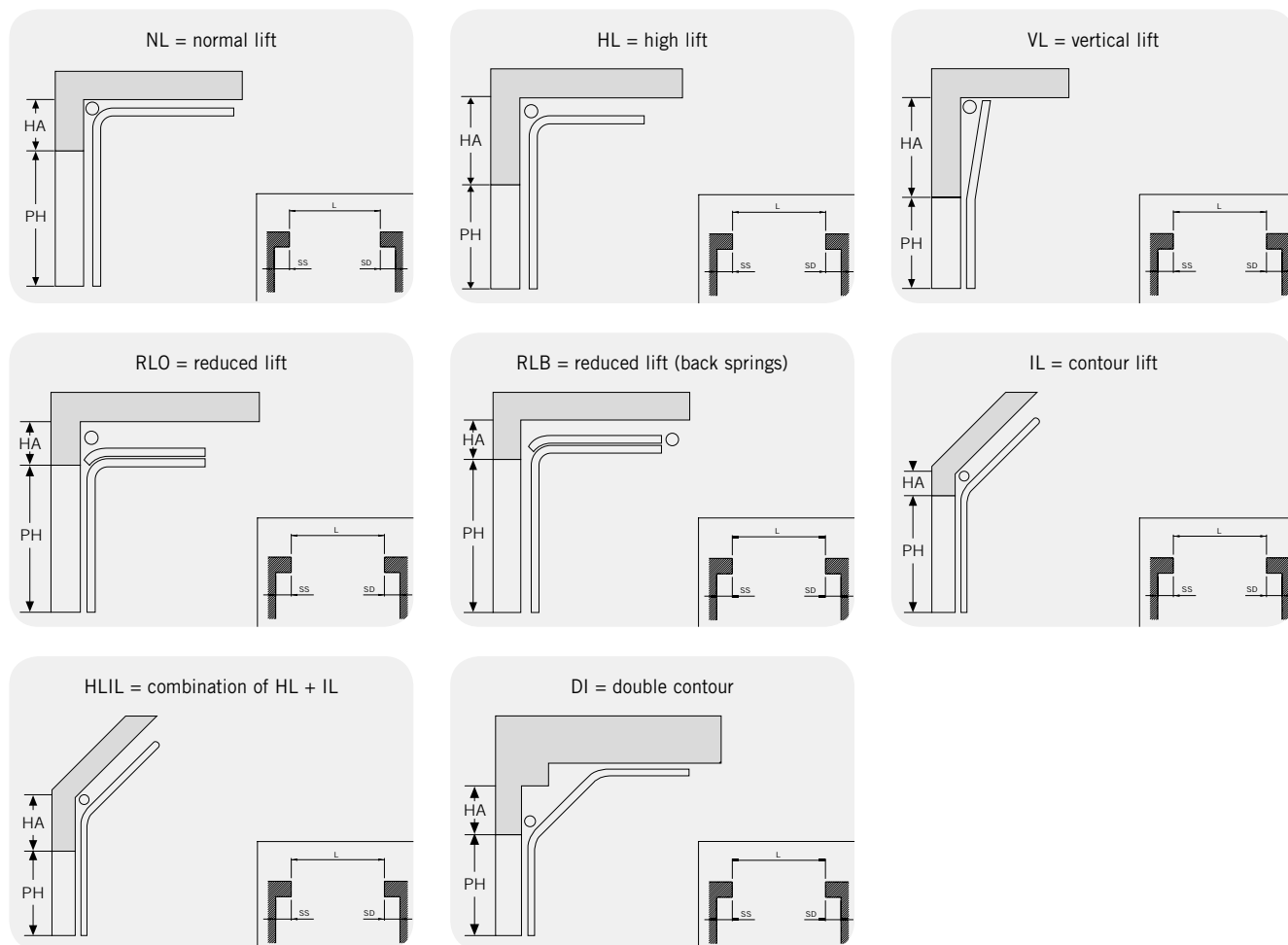

Overall Size and Tracking Table

Industrial overhead doors									
	PL (mm)		PH (mm)		HA (mm)		SS (mm)	SD (mm)	Panel weight
	Min.	Max.	Min.	Max.	Min.	Max.	Min.	Min.	Max.
Normal (NL)	1800	8000	1780	5570	420		150	150	500 kg
				7000	510				700 kg
High (HL)	1800	8000	1780	7000	960	2860	150	150	650 kg
						4460			575 kg
Vertical (VL)	1800	8000	1780	5550	PH+300		150	150	600 kg
Reduced (RLO)	1800	6500	1780	4500	285		200	200	290 kg
Reduced (RLB)	1800	6500	1780	4500	200		200	200	290 kg
Contour (IL)	1800	7000	1780	5550	490		150	150	500 kg
				>5550	550				700 kg
Double Contour (DI)*	1800	7000	1780	5550	490	3150	150	150	
HLIL= HL+IL	1800	7000	1780	5550	960	4460	150	150	575 kg

Key

NL - Normal lift
HL - Semi-vertical sliding action
VL - Vertical lift

RLB - Reduced lift with back springs
RLO - Reduced lift with front springs
IL - Contour lift
DI - Double contour lift

* Only possible upon confirmation by the Technical Department

Dod

Dod drive unit reliably automates all types of sectional overhead doors.

Heavy-duty motor, for total reliability

Reduced and compact sizes; can be easily installed when space is at a premium. Modern and smart design.

Can be used on different applications on sectional overhead doors:

- In line installation
- Pinion and chain installation.

Easy to install; keyed on the drive shaft or indirectly driven by pinion and chain, does not require other moving parts.

Adjustable rotary limit switch unit.

Two manual release systems:

- With cable: fast release system.
- With drive rod or chain.

After releasing the automation, the door can be manually operated.

Tried and tested, reliable components, already fitted on other DITEC automations.

Their indirect drive installation allows operating speed to be adjusted according to requirements or tackles applications when side space is not available.

Dod automations are complete with security, control and monitoring parts compliant with current standards.

Dimensions

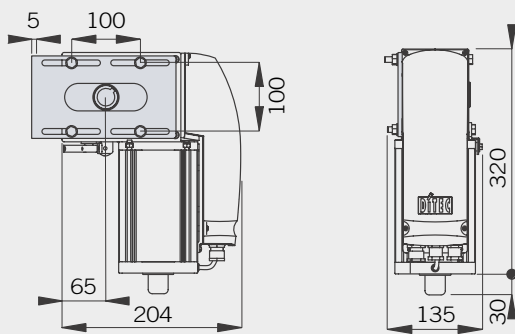

PLUS
Compact and powerful

Motor configurations

External and vertically mounted

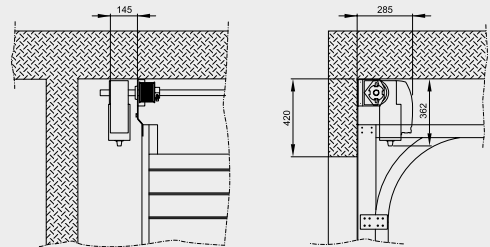

External and horizontally mounted

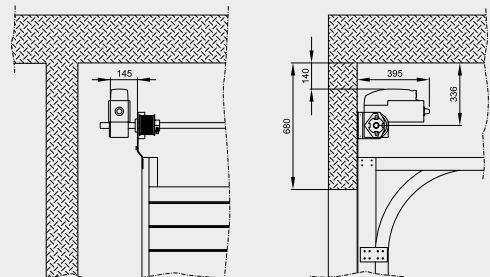

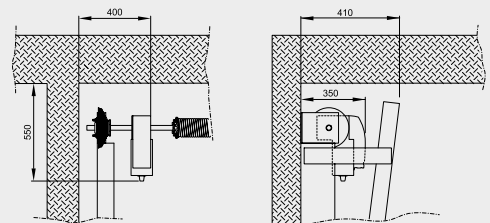

Internal and vertically mounted - only VL sliding system

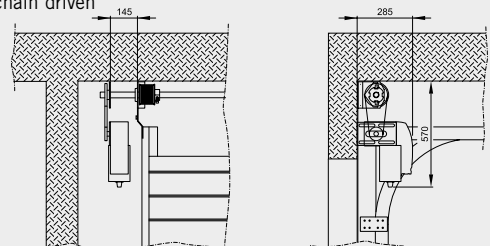

Pinion and chain driven





Technical specifications

Description:	Motorised version*	Automatic version	Three-phase automatic version
Electromechanical actuator	DOD 14 PS	DOD 14	DOD 15
Duty class	4 - heavy duty	4 - heavy duty	4 - heavy duty
Intermittent operation	S2 = 30 min / S3 = 50%	S2 = 30 min / S3 = 50%	S2 = 30 min / S3 = 50%
Power supply	 230 V~ / 50 Hz	 230 V~ / 50 Hz	 400 V~ / 50 Hz
Insulation class	class 1	class 1	class 1
Input	3 A	3 A	1,2 A
Torque / Thrust	60 Nm	60 Nm	65 Nm
Drive shaft rpm	22 RPM	22 RPM	32 RPM
Release for manual opening	by cable / handle type	by cable / handle type	by cable / handle type
Operating temperature	-20°C / +55°C	-20°C / +55°C (-35°C / +55°C con NIO attivato)	-20°C / +55°C
Protection rating	IP 54	IP 54	IP 54
Product dimensions	135x264x350	135x264x350	135x264x350
Open-close control	pre-wired switch		
Control panel		E1A	E1T

*Hold-to-run operation only

System functions

Description:	Automatic version	Three-phase automatic version
Electronic panel	E1A	E1T
Type of use	for 1 motor 230 V~ built-in radio	for 1 three-phase motor 400 V~ (multifunction)
Mains power supply	 230 V~ / 50 Hz	 400 V~ / 50 Hz
Motor power supply	230 V~ / 5 A	400 V~ / 6 A
Accessories power supply	24 V= / 0.5 A	24 V= / 0.5 A
Flashing light gives 3 seconds warning before automatically closing the gate	230 V	24 V
Gate open warning light warns the user if gate is not fully closed	limit switch	limit switch
Courtesy light	■	
Limit switch provision	■	■
Force adjustment control	transformer	
ODS - Obstruction detection system causes the gate to stop or reverses operation when an obstruction is detected	■	
Operation time adjustment	■	
Open control	■ (with dip-switch)	■ (with dip-switch)
Partly open control	■ (with radio only)	■
Close control	■	■
Automatic timed close control	■	■
Inching control	■	■
Hold-to-run control	■	■
Stop safety device	■	■
Reverse operation safety device	■	■
Safety Test facility	■	■
NIO - The antifreeze system ensures full motor efficiency even at very low temperatures	■	
Operating temperature	-20°C / +55°C (-35°C / +55°C with NIO enabled)	-20°C / +55°C
Protection rating	IP 55	IP 55
Product dimensions (mm)	187x261x105	238x357x120

Accessories

All accessories are genuine DITEC accessories and have been designed to add value to the door, to ensure long and reliable operation and peace of mind.



GOL 4 transmitters

Fixed code four channels, with cloning option, or with rolling code system.

Certified and directive compliant.



GOL 4W transmitters

Four-channel in metal containers for easy use even when wearing gloves.



Xel 2 infrared beam photocell

Allows the automation to operate at the highest safety levels.

Can be wall or column mounted. Modulated infrared beam.



Deb 08 key-operated handle

Key-operated handle with 8 m long cord for remote-operated release system.



Lamp

230 V and 24 V flashing light with flashing operation controlled from the control panel.

Dod accessories

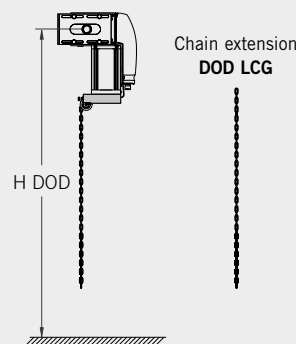

- Compatible with DOD 14 and DOD 15 (also suitable for already existing automations as long as they are correctly configured - version 1.0)
- The full system includes the motor plus the DOD SBC chain-operated release with standard chain plus a 3800 mm long extension if required

H DOD	DOD LCG Chain extension
≤ 5000	NO
≤ 9000	YES

When building the system, only use DITEC accessories and safety devices.

DITEC automations all feature CE marking and are designed and built in compliance with the safety requirements of the Machinery Directive (2006/42/EC), of the Electromagnetic Compatibility Directive (2004/108/EC) and of the Low Voltage Directive (2006/95/EC) and of other Directives, laws, specific standards for special products and situations.

DITEC S.p.A. reserves the right to make changes which may improve the products. DITEC S.p.A. always strives to improve its products. For this reason, the technical details featured in this catalogue are not binding.

The pictures shown in this leaflet were taken with the consent of those concerned or in public locations.

Further information can be found in the Technical Manuals available at the website: www.ditec.it



DITEC S.p.A. Via Mons. Banfi, 3 21042 Caronno P.Ia (VA) Italy Tel. +39 02 963911 Fax +39 02 9650314
www.ditec.it ditec@ditecva.com

DITEC BELGIUM LOKEREN Tel. +32 9 3560051 Fax +32 9 3560052 www.ditecbelgium.be **DITEC DEUTSCHLAND** OBERURSEL
Tel. +49 6171 914150 Fax +49 6171 9141555 www.ditec-germany.de **DITEC ESPAÑA S.L.U.** ARENYS DE MAR Tel. +34 937958399
Fax +34 937959026 www.ditecespana.com **DITEC FRANCE** MASSY Tel. +33 1 64532860 Fax +33 1 64532861 www.ditecfrance.com
DITEC GOLD PORTA ERMESINDE-PORTUGAL Tel. +351 22 9773520 Fax +351 22 9773528/38 www.goldporta.com **DITEC SWITZERLAND**
BALERNA Tel. +41 848 558855 Fax +41 91 6466127 www.ditecswiss.ch **DITEC ENTREMATIC NORDIC** LANDSKRONA - SWEDEN
Tel. +46 418 514 00 Fax +46 418 513 55 www.ditecentrematicnordic.com **DITEC TURCHIA** ISTANBUL Tel. +90 21 28757850
Fax +90 21 28757798 www.ditec.com.tr **DITEC AMERICA** ORLANDO-FLORIDA-USA Tel. +1 407 8880699 Fax +1 407 8882237
www.ditecamerica.com **DITEC CHINA** SHANGHAI Tel. +86 21 62363861/2 Fax +86 21 62363863 www.ditec.cn